

PIR Sensor (320, 320B, 320P and 320PB)

The PIR Sensor is a compact sensor that provides energy saving functions in a DALI system. It can turn the lights on when its coverage area is occupied, and off when it is unoccupied. The sensor's settings are adjusted using Helvar's Designer or Toolbox software.

Due to its excellent detection performance, the PIR Sensor is especially suitable for applications where small or slow movements take place for extended periods of time, such as offices or classrooms. Since its detection sensitivity is less dependent on movement direction than that of most PIR sensors, fewer units are required to reliably cover a target area.

The unit can be mounted into a ceiling void or onto a solid surface using Helvar's SBB-C (white) or SBB-CB (black) mounting box (sold separately).

Key Features

- Excellent detection performance through high sensitivity and multidirectional coverage.
- 10 mA DALI current consumption.
- Compact and functional design.
- Programmable in Designer and Toolbox.

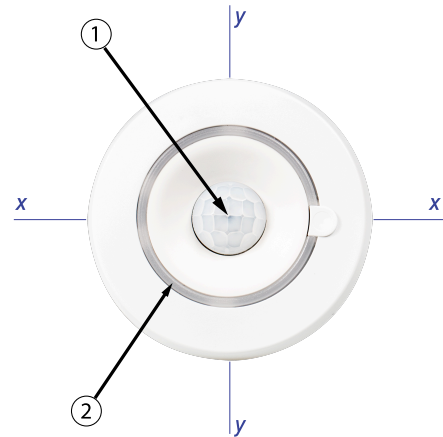

1. PIR sensor
2. Status LED

Presence Detection Coverage at 2.5 m Height

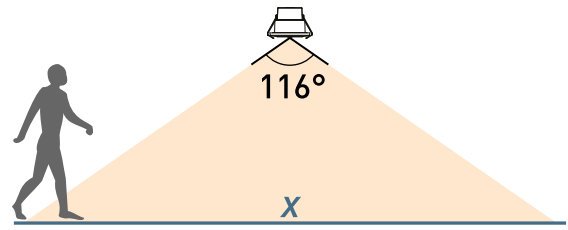
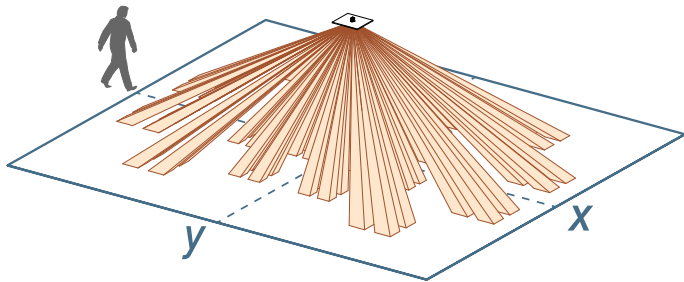

X-Axis Coverage

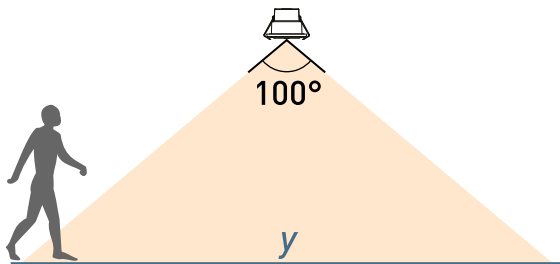

Y-Axis Coverage

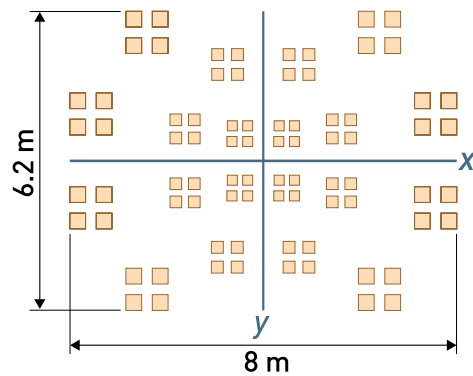

Detection Pattern at Floor Level

Dimensions (mm)

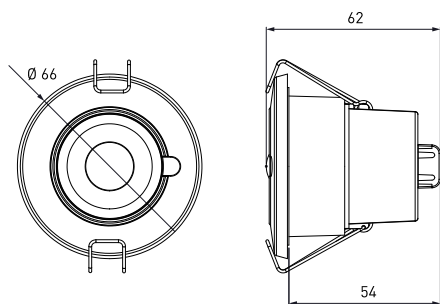

320, 320B

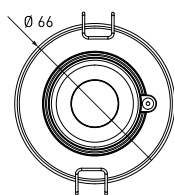

320P and 320PB

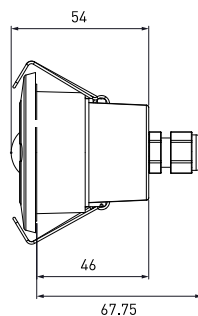

Connections

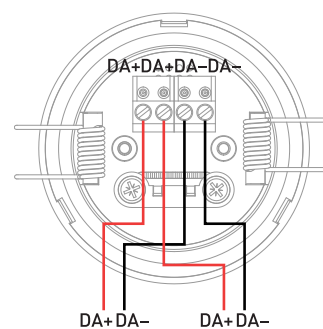

Technical Data

Connections	
DALI:	Removable connector block
Wire section:	0.5 mm ² – 1.5 mm ² solid or stranded
Cable rating	All cables must be mains rated.

Electrical data	
DALI supply input:	12 V – 22.5 V
DALI consumption:	10 mA Max

Sensors	
Presence detector:	Passive infrared (PIR)

Operation	
Start-up time:	≤1 sec

Operating and storage conditions	
Ambient temperature:	0 °C to +50 °C
Relative humidity:	Max. 90 %, noncondensing
Storage temperature:	-10 °C to +70 °C

Compatibility	
Designer:	5.4 or later
Toolbox:	2.4.2 or later

Mechanical data	
Max. recommended mounting height:	4 m
Presence detection coverage area:	46 m ² @ 2.5 m mounting height
Mounting hole diameter:	51 mm +/- 1 mm
 Note: If replacing older sensor then 52 mm to 55 mm mounting hole is acceptable.	
Ceiling thickness:	Maximum 25mm
Bezel diameter:	66 mm
Recommended clearance depth:	10 cm (with cable cover, incl. 5 cm for cabling)
Material (casing):	Nonflammable PC/ABS (UL94-V0)
Finish/Colour:	320, 320P: Semi-matt / White RAL 9003
	320B 320PB: Semi-matt / Anthracite grey RAL 7016
Weight:	66.3 g
IP rating:	320, 320B: IP30 [IP20 cable cover] 320P, 320PB: IP65

Conformity and standards	
Conformity:	
EMC emission:	EN 55015
EMC immunity:	EN 61547
Safety:	EN 61347-2-11
Environment:	Complies with WEEE and RoHS directives.